

SB/SBA

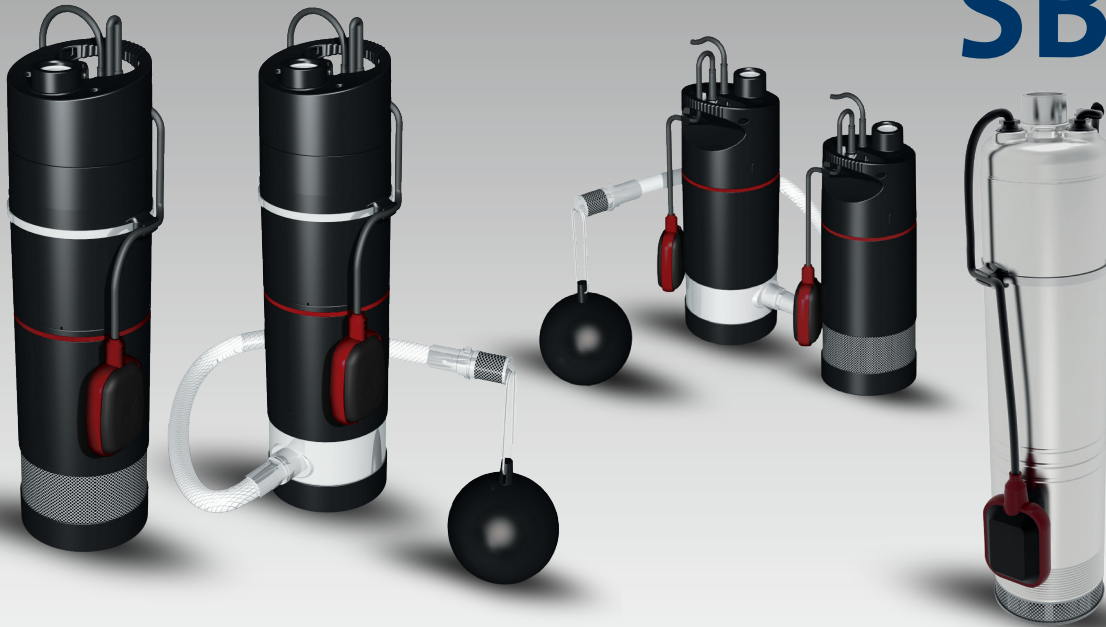

Further product
documentation



net.grundfos.com/qr/i/99057358

be
think
innovate

GRUNDFOS 

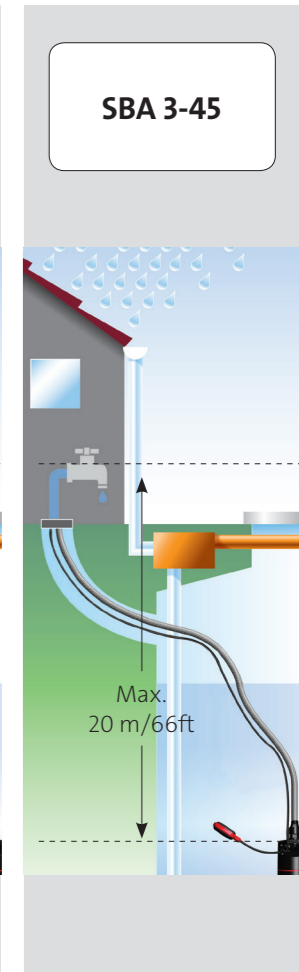
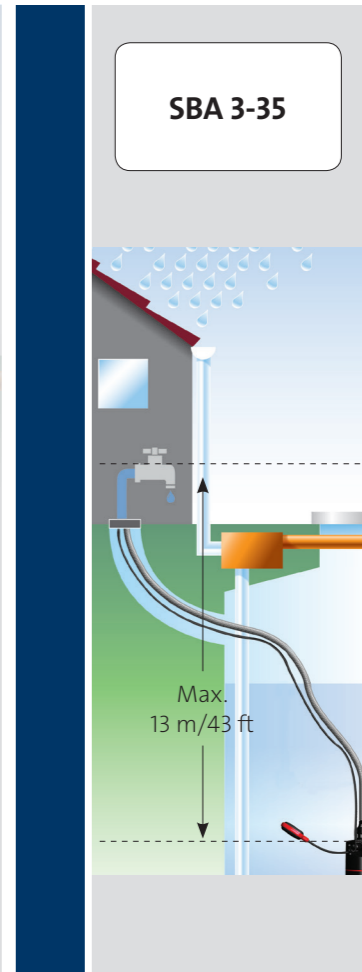
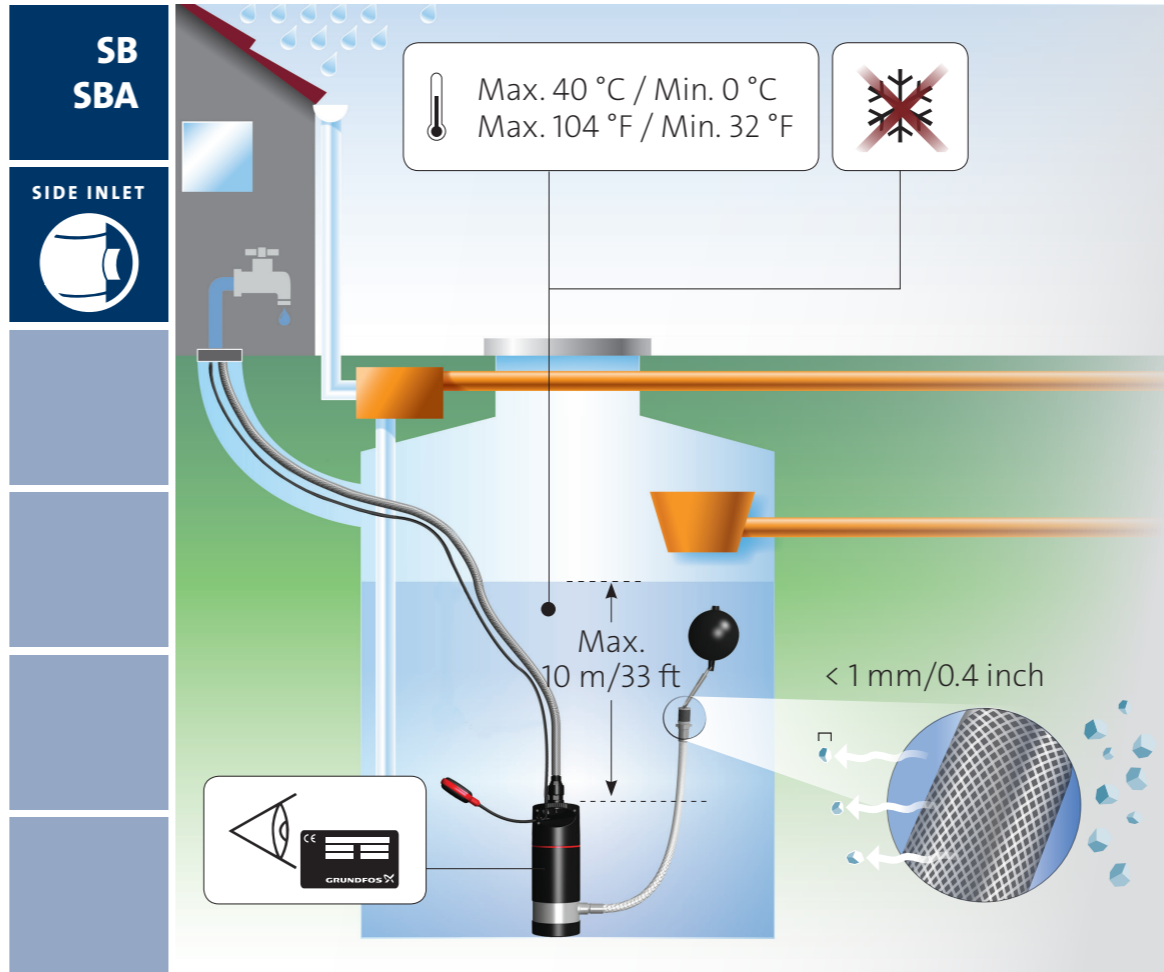
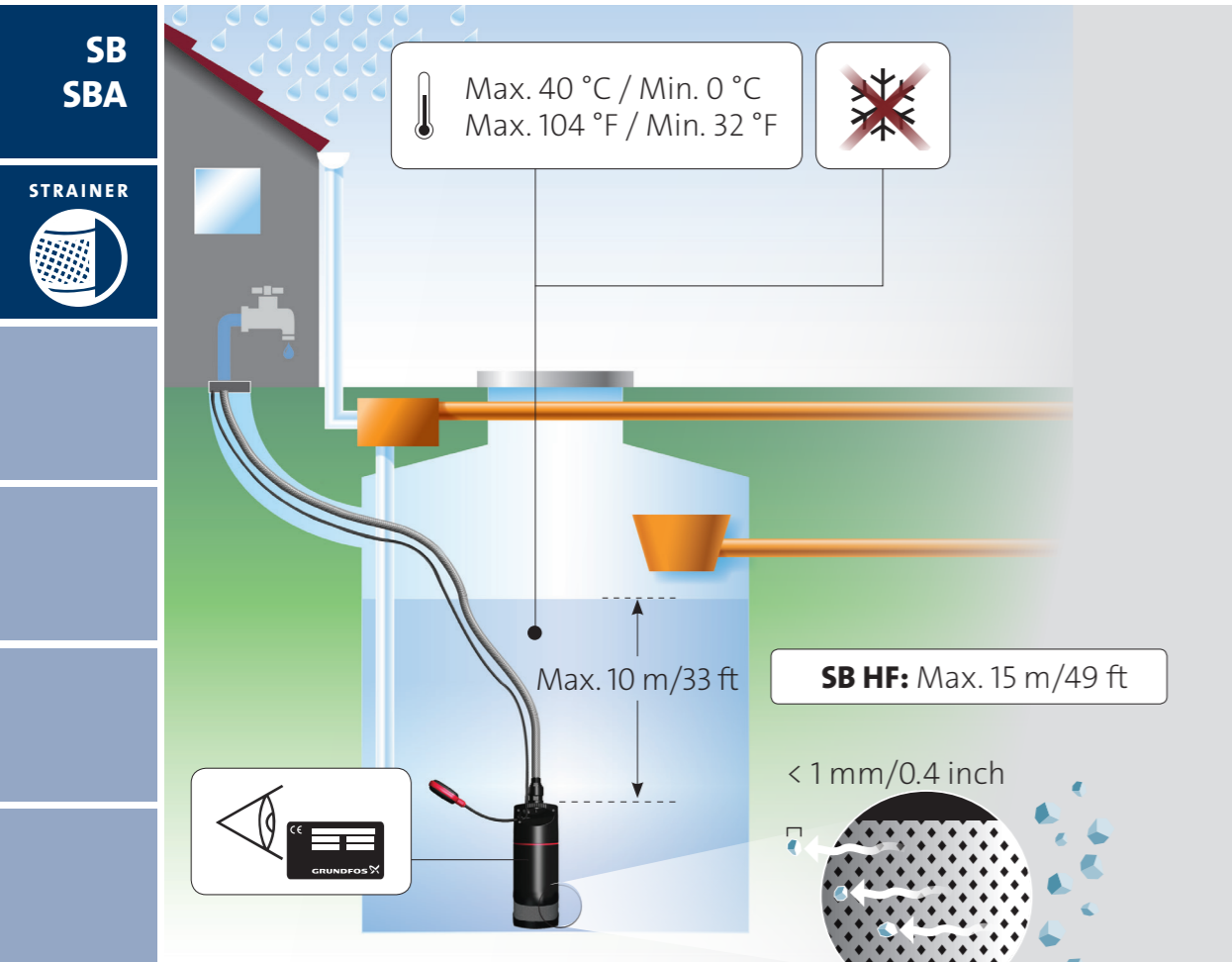

SB
STRAINER

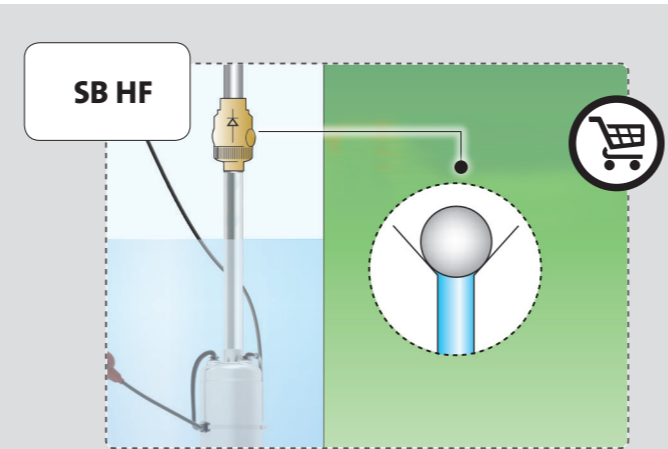
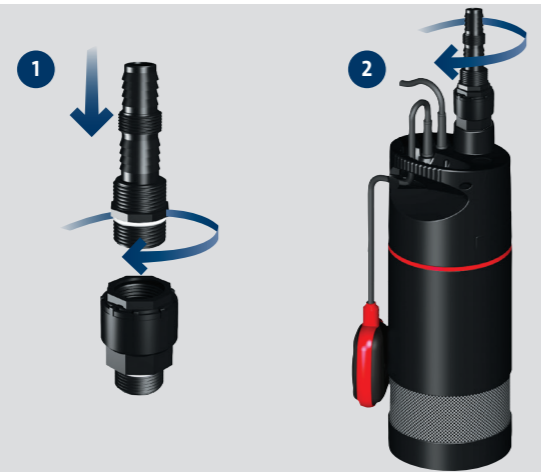
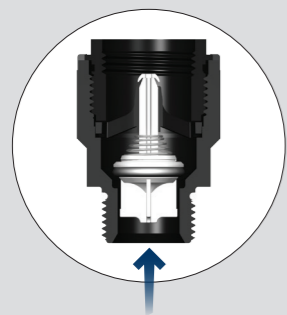

SBA
STRAINER

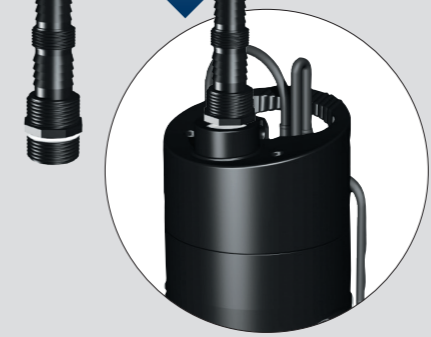

SB
SIDE INLET

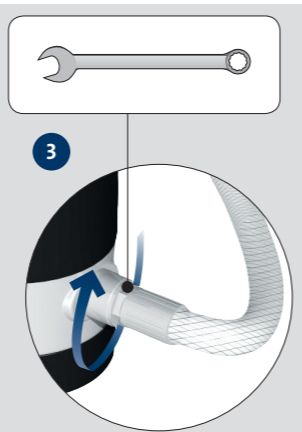
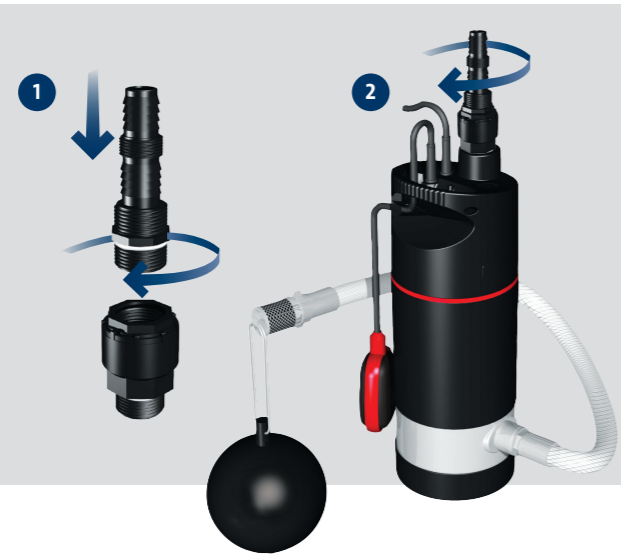
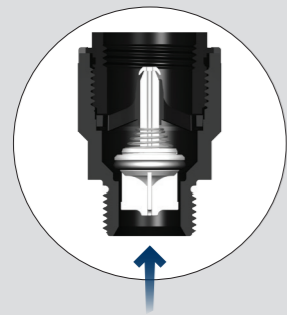

SBA
SIDE INLET

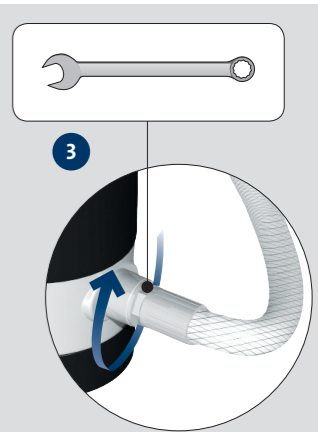
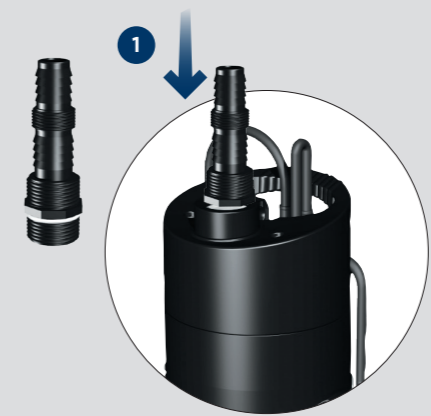

SB
SBA

STRAINER

SIDE INLET

3/4"

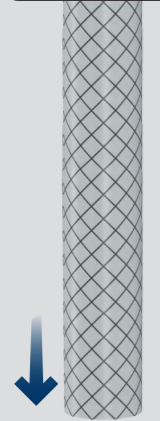

1"

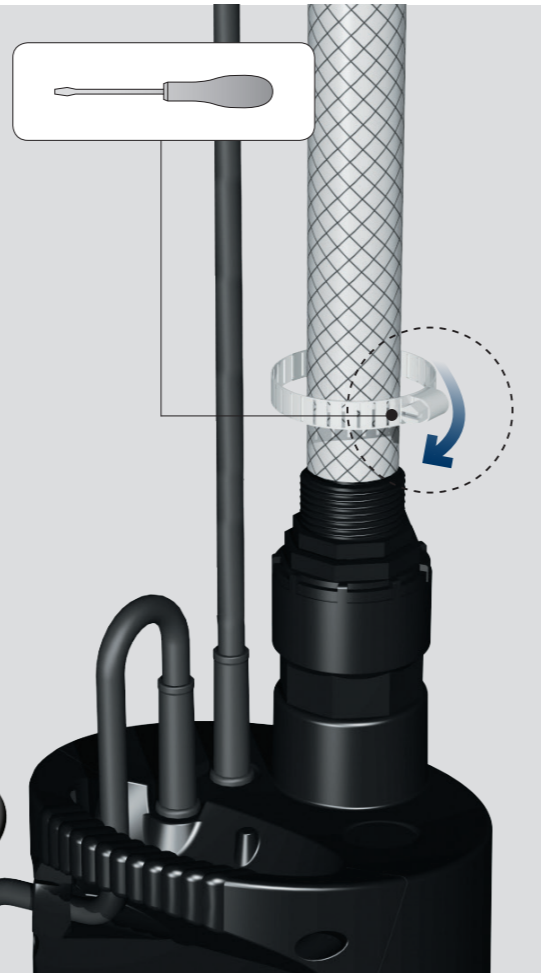
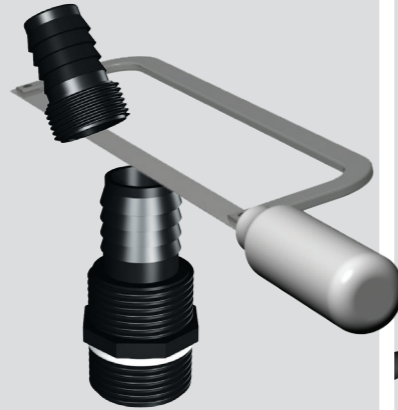
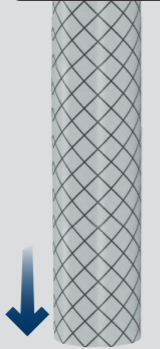

SB HF

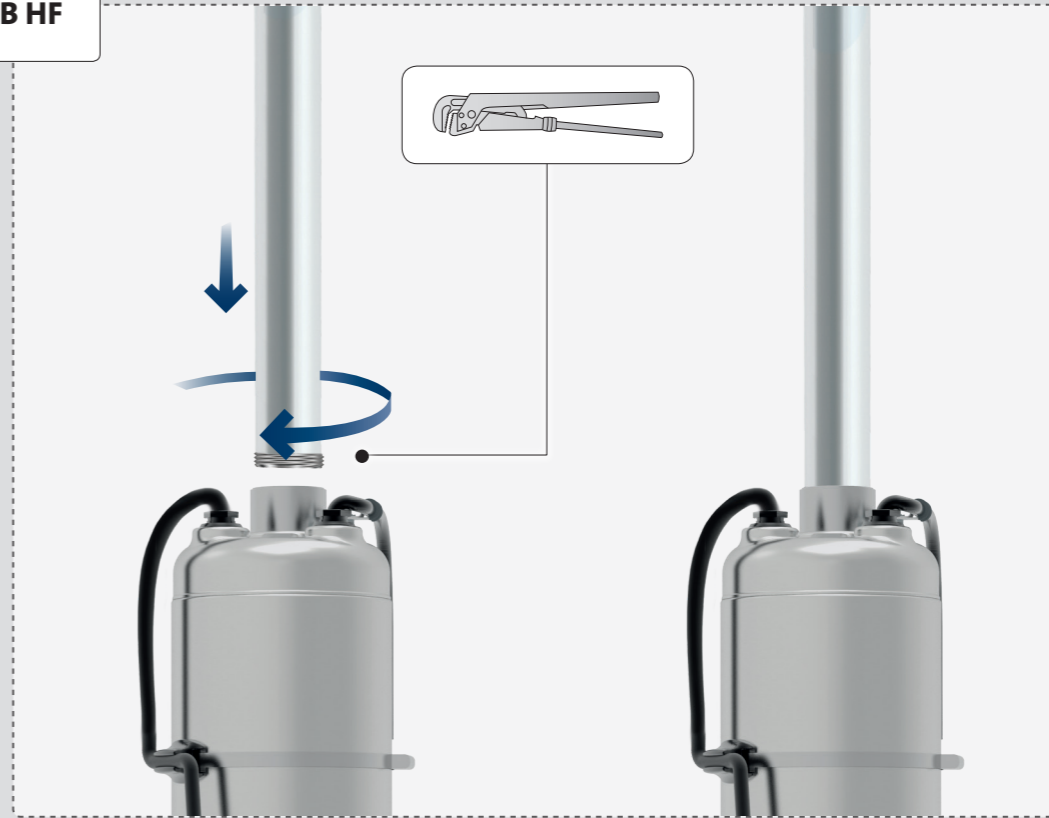

SB
SBA

STRAINER

SIDE INLET

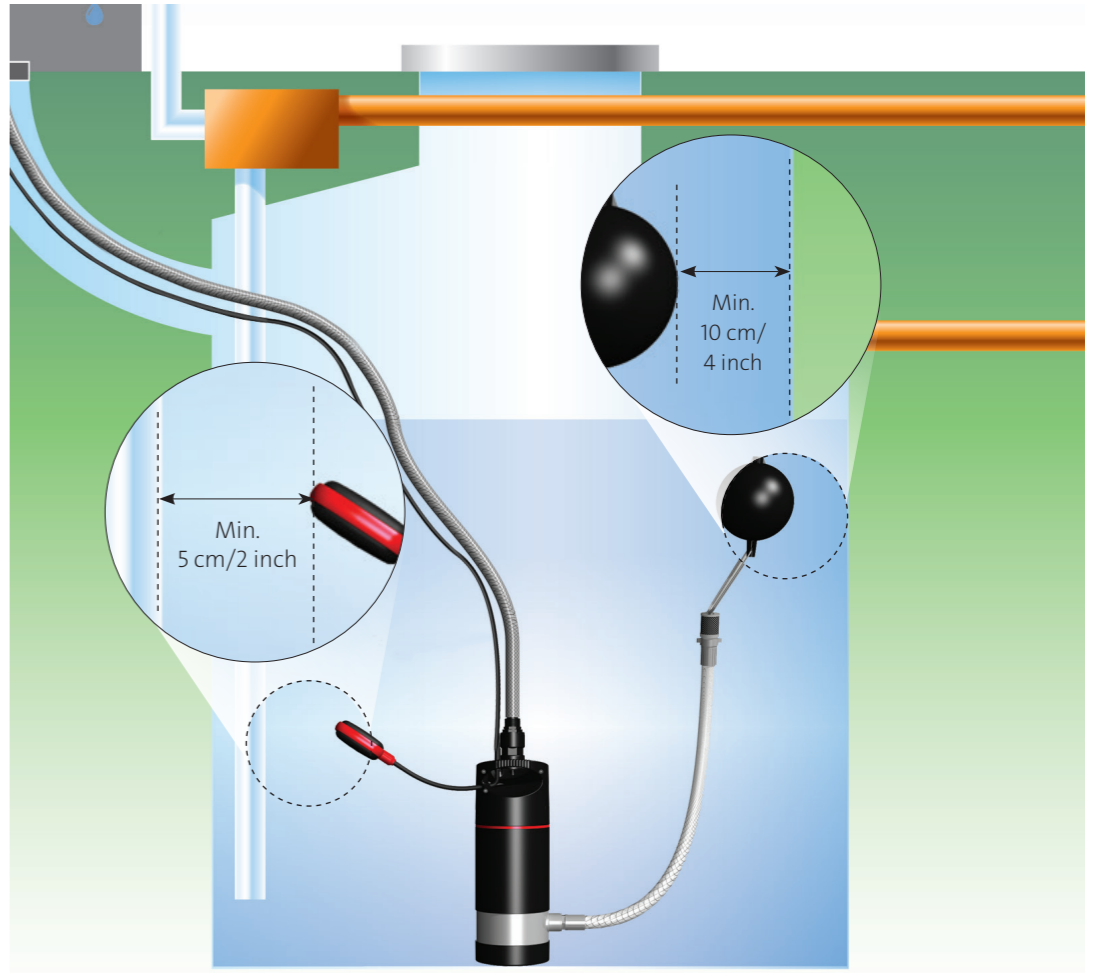
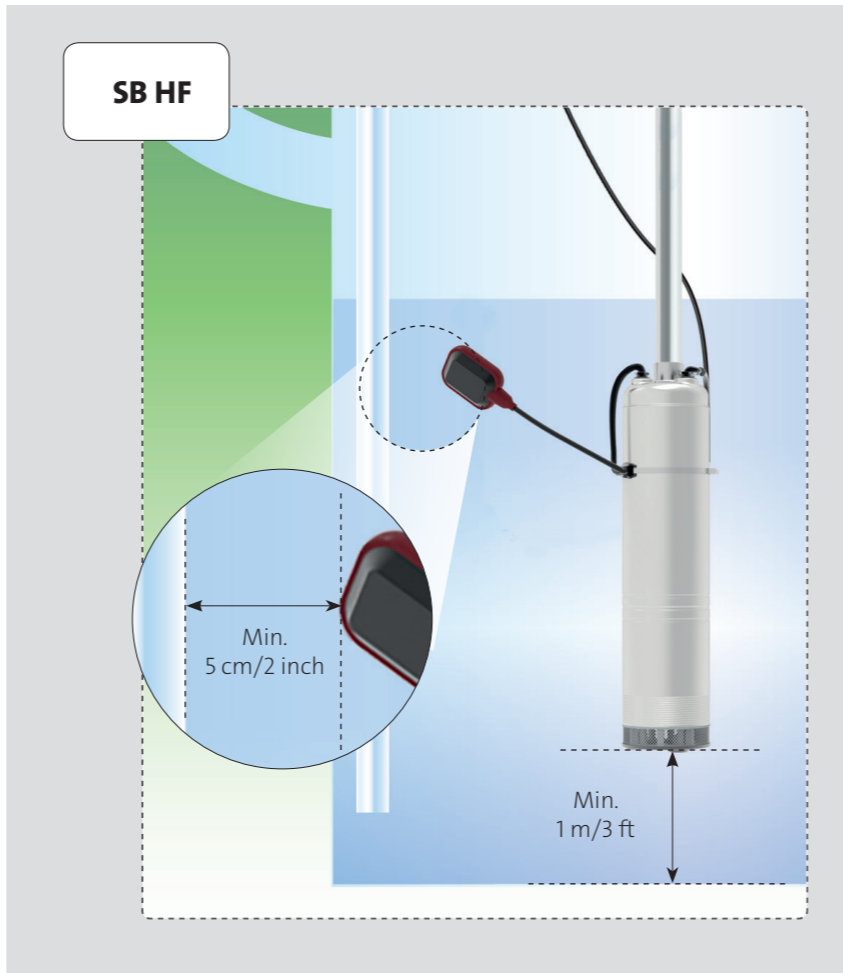
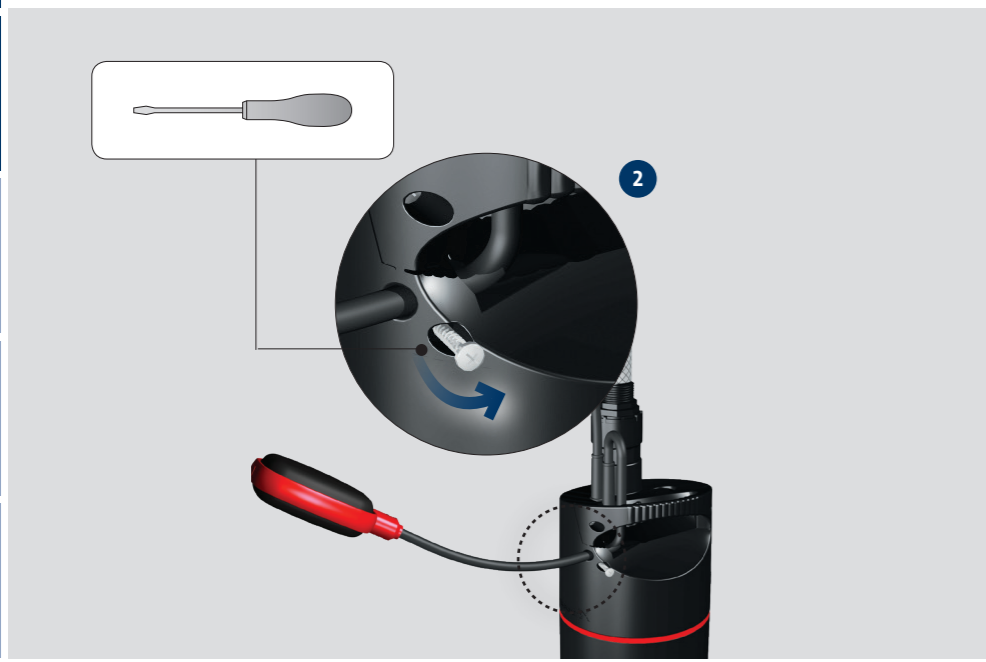
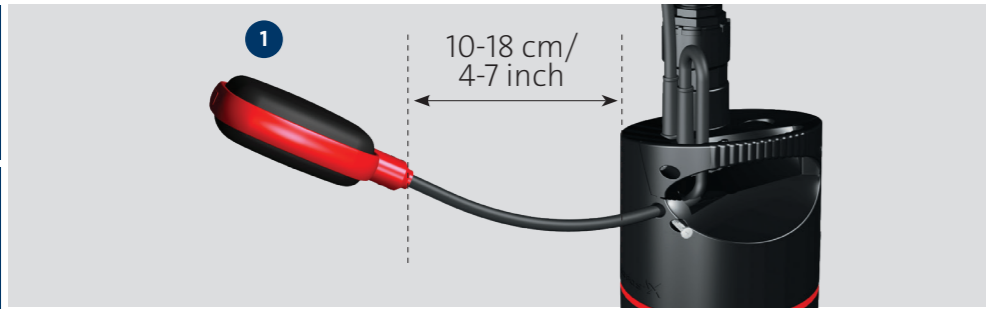

SB

STRAINER

SIDE INLET

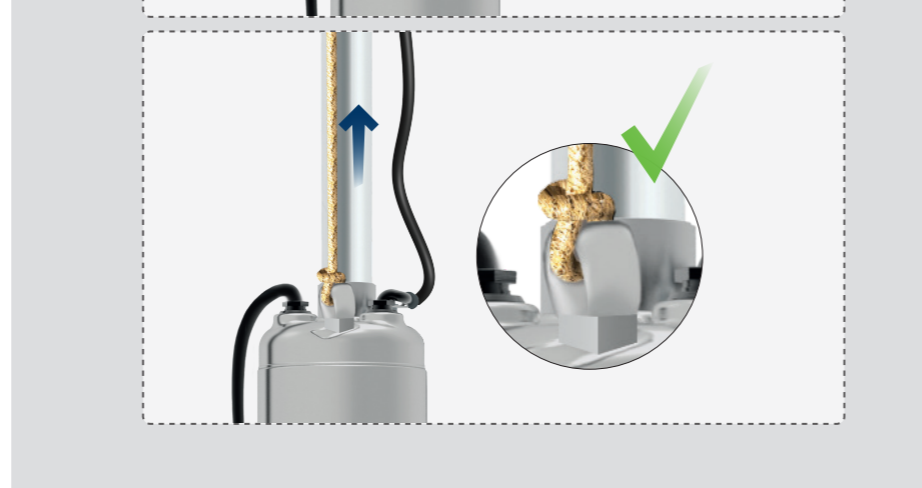
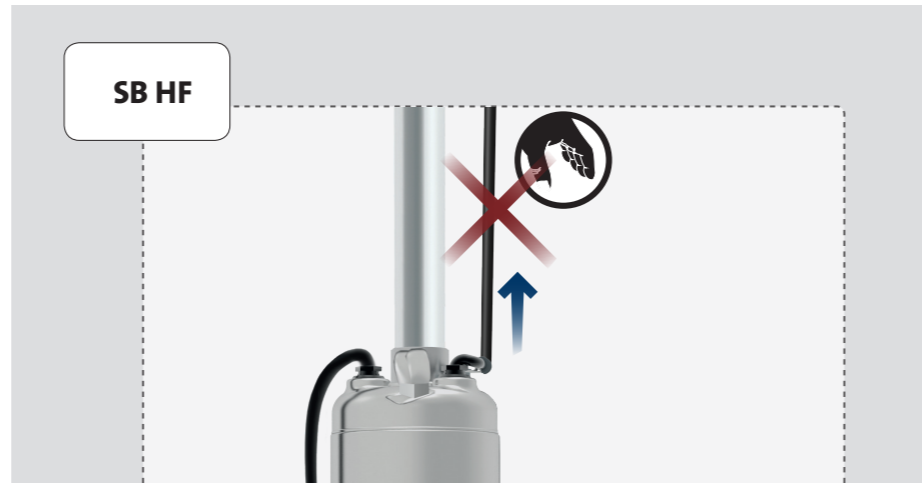
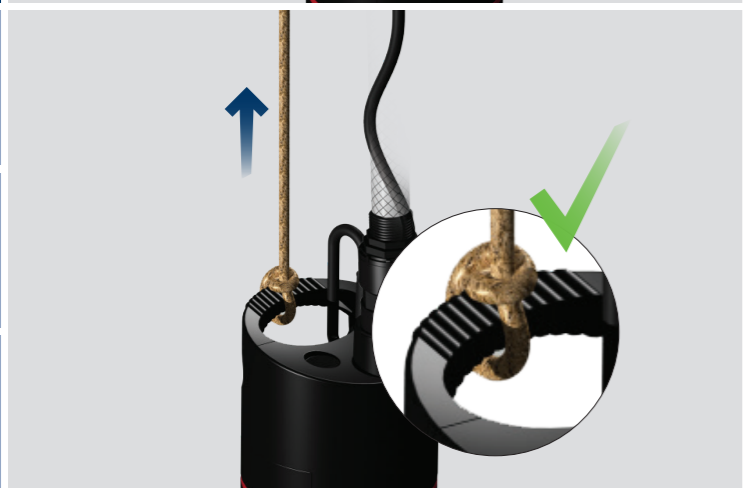

SBA

STRAINER



SBA

SIDE INLET

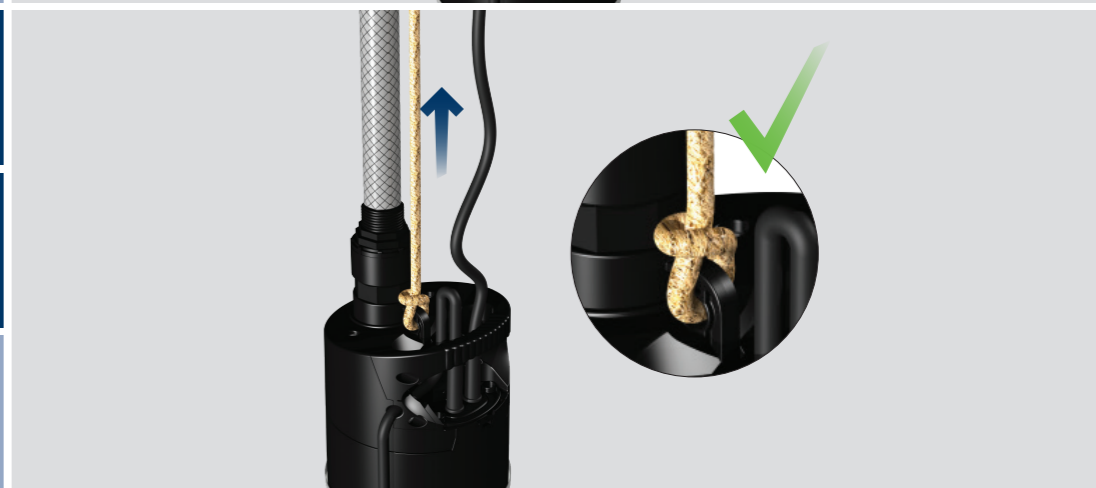

SB
SBA

STRAINER

SIDE INLET

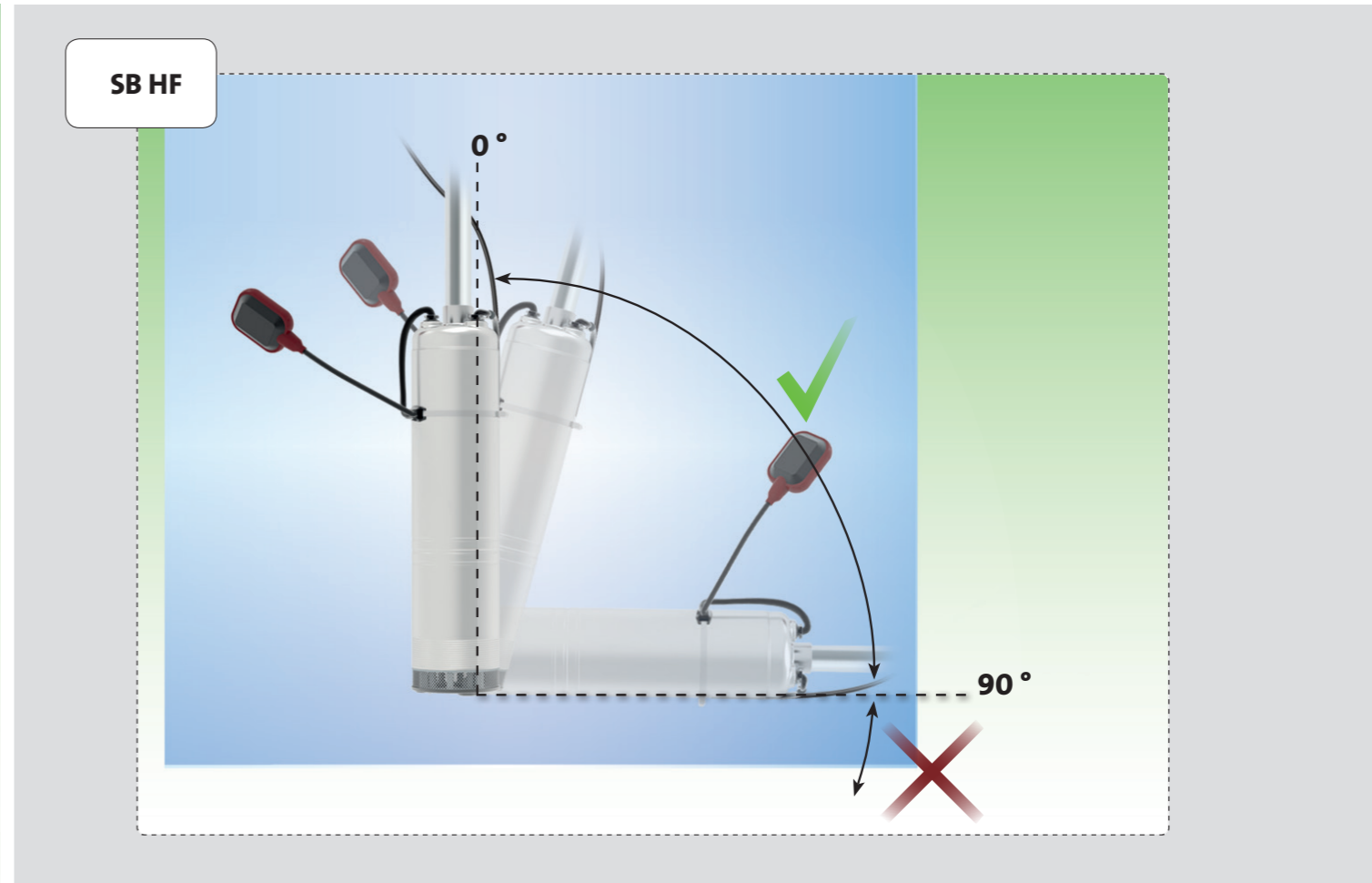
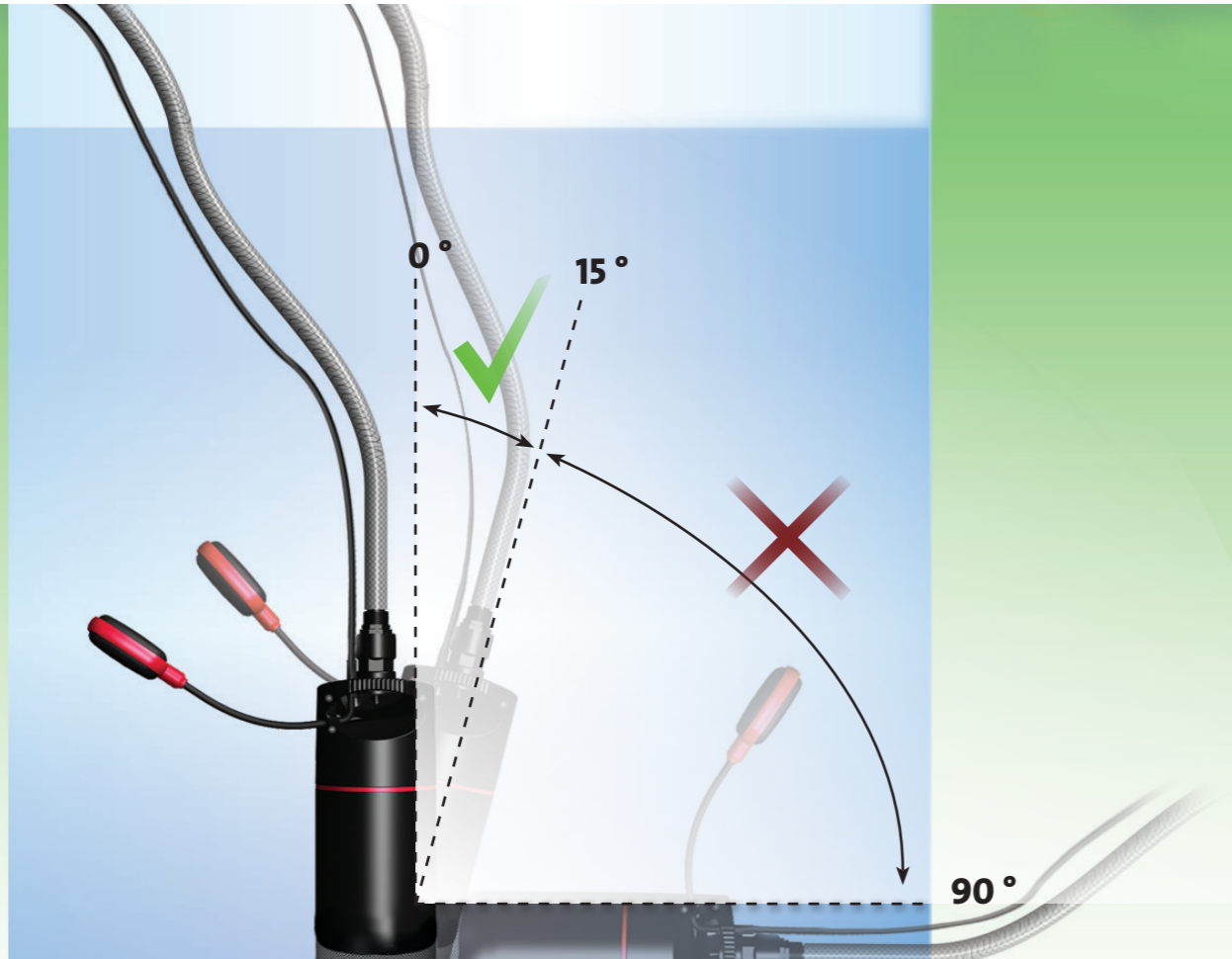

SB
SBA

STRAINER

SIDE INLET



Max. 20 starts per 60 minutes.

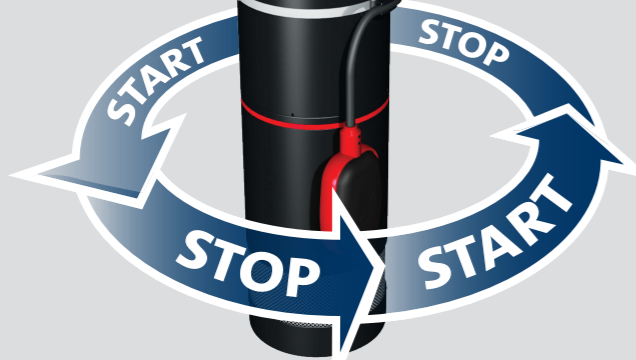
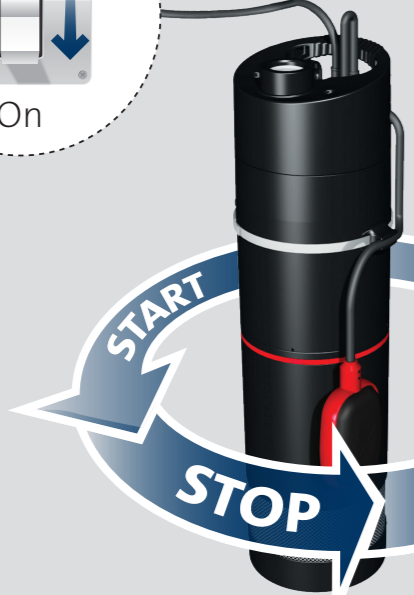
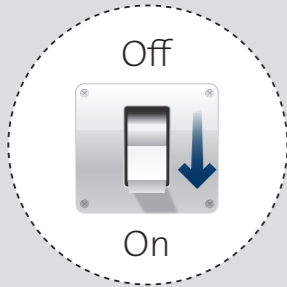

SB HF



Max. 30 starts per 60 minutes.

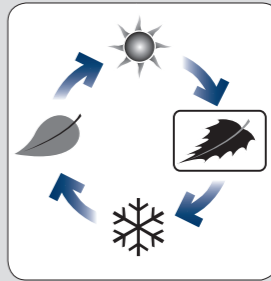
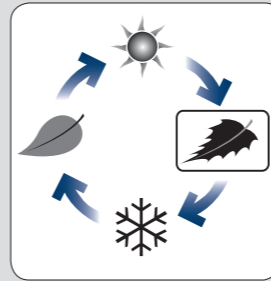
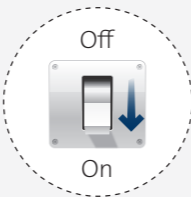

be think innovate

98159397 0418

ECM: 1232283

GRUNDFOS Holding A/S
Poul Due Jensens Vej 7
DK-8850 Bjerringbro
Tel: +45 87 50 14 00
www.grundfos.com

GRUNDFOS 

The name Grundfos, the Grundfos logo, and be think innovate are registered trademarks owned by Grundfos Holding A/S or Grundfos A/S, Denmark. All rights reserved worldwide.